

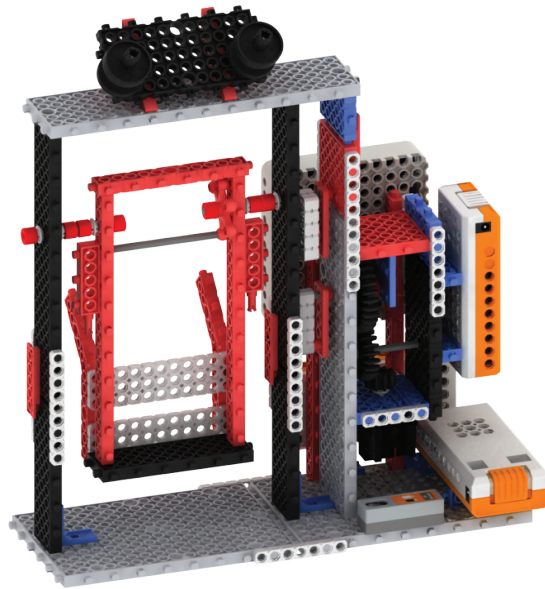

25 Columpio

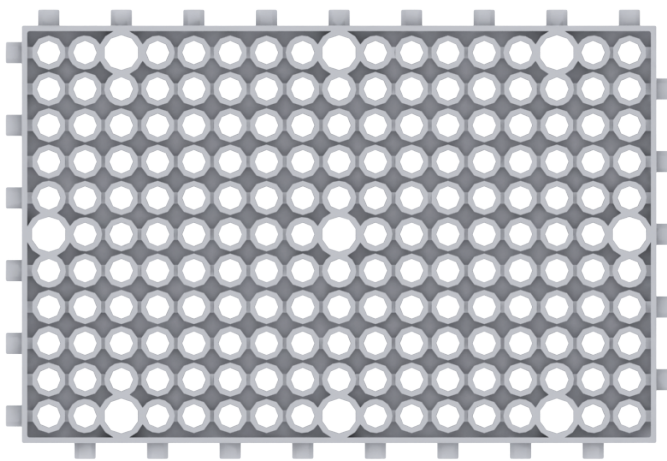

Piezas



Bloque 11x17 (2)

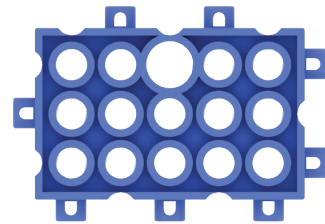

Bloque 3x5 (3)



Bloque N 1x5 (4)



Bloque N 1x7 (4)



Bloque N 1x9 (4)



Bloque N 1x11 (2)

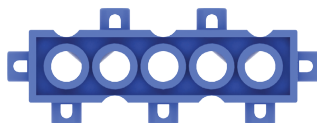

Bloque 1x5 (5)

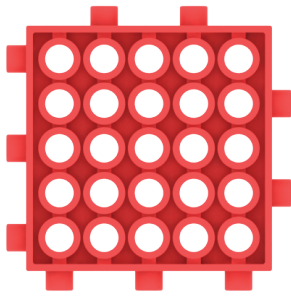

Bloque 5x5 (2)

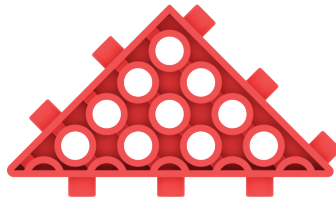

Bloque triangular (2)

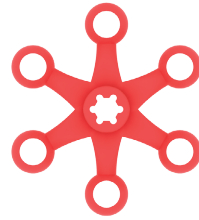

Engranaje básico (1)

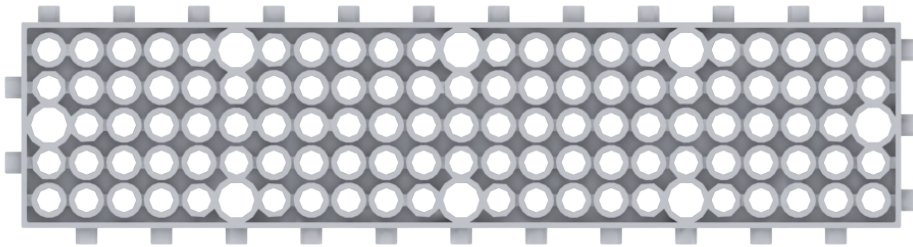

Bloque 5x23 (2)

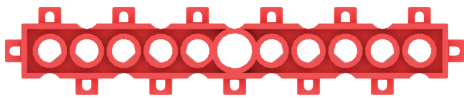

Bloque 1x11 (1)

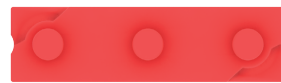

Bloque de unión 1 (4)

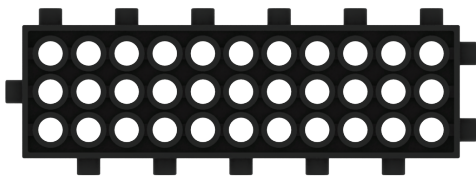

Bloque 3x11 (3)



Bloque N 3x11 (2)

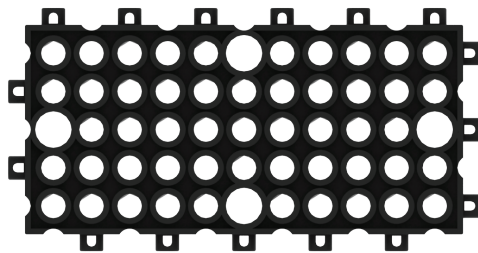

Bloque 5x11 (2)



Rueda polea (2)



Manivela (2)

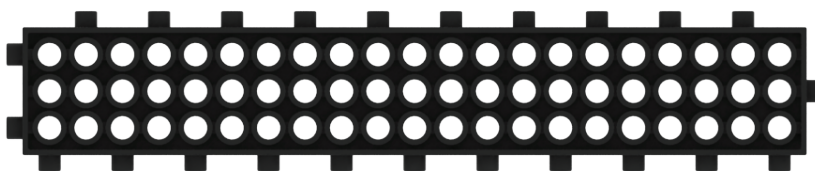

Bloque 3x21 (2)



Adaptador L (4)



Goma de eje roja (10)



Arandela (11)



Unión de ejes (2)

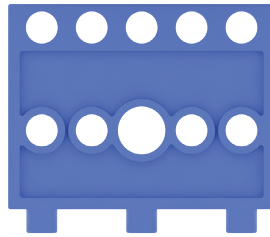

Soporte de motor (1)



Sensor de infrarrojos (1)

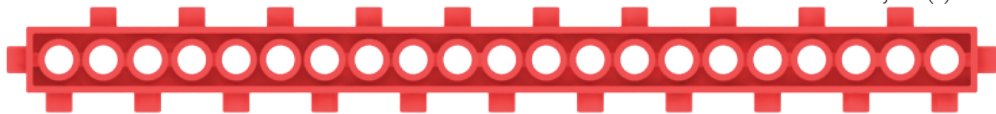

Bloque 1x21 (4)



Engranaje L (1)



Engranaje M (1)



Engranaje S (1)



Bloque N 2x5 (2)

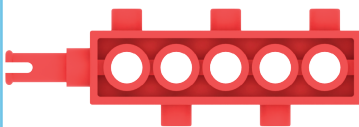

Bloque con eje (2)

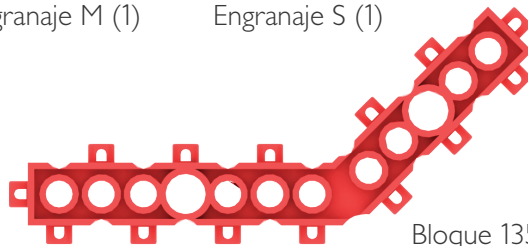

Bloque 135° (2)



S-shaft Eje S (2)



M-shaft Eje M (3)



L-shaft Eje L (2)



Cable de conexión (3)

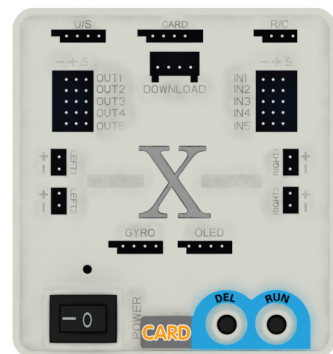

Placa base (1)

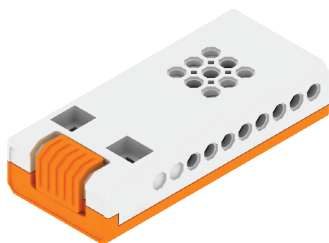

Portapilas o portabaterías 1 (1)

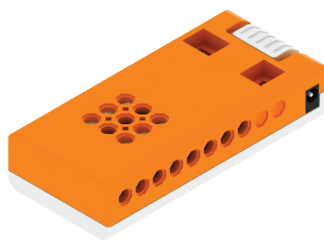

Portapilas o portabaterías 2 (2)

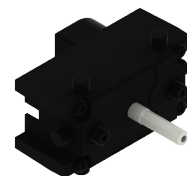

Motor 2(1)

01

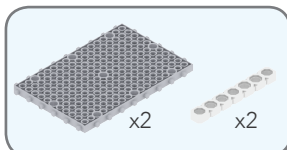
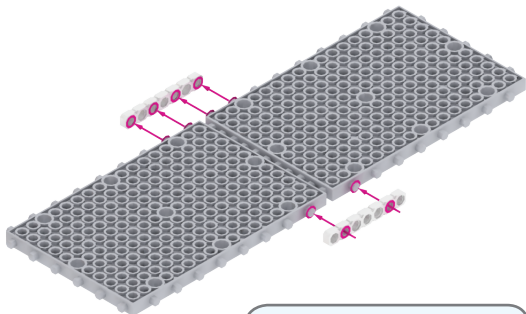

02

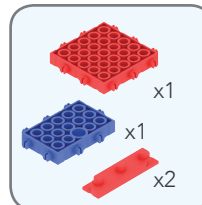
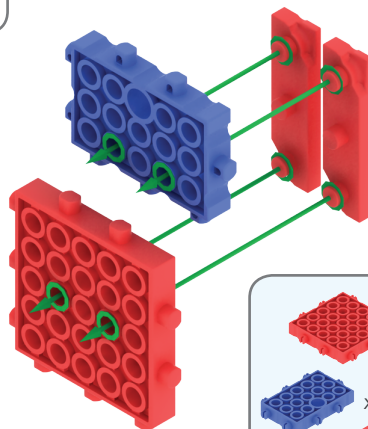

03

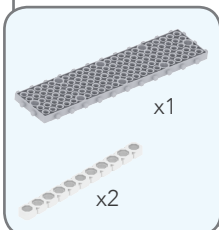
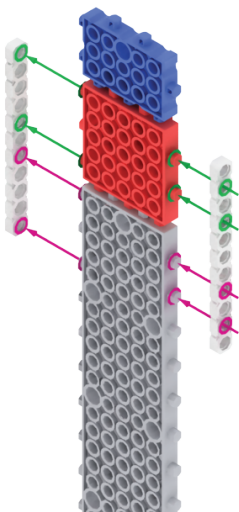

04

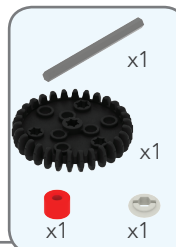
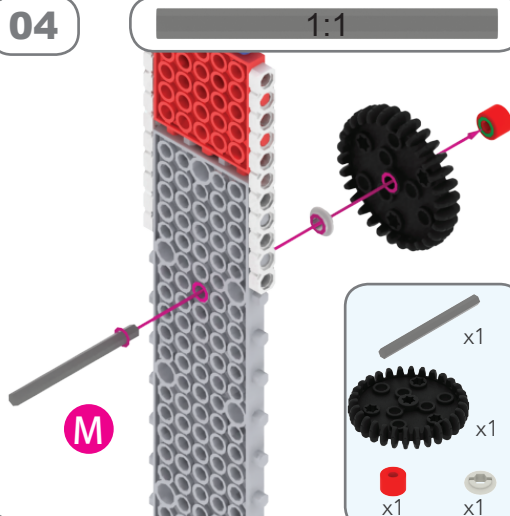

05

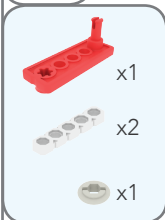
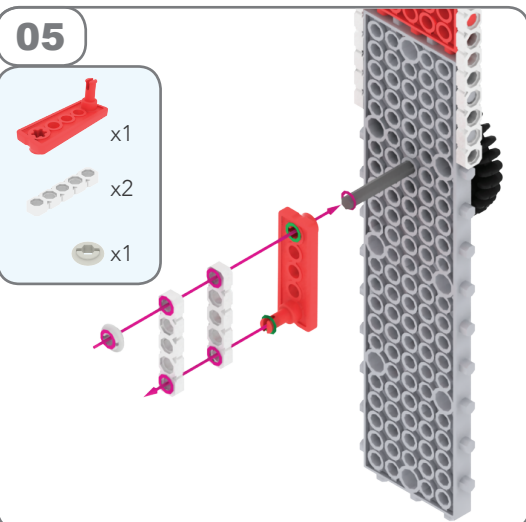

06

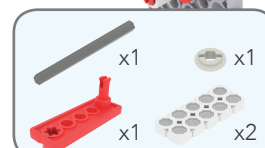
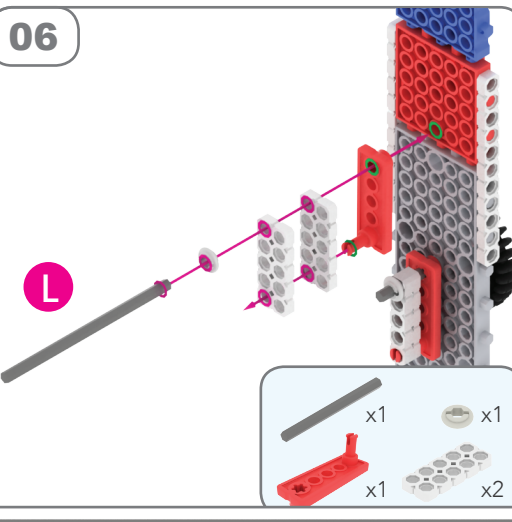

Nota: Este triángulo rojo ▲ señala la posición

07

X2

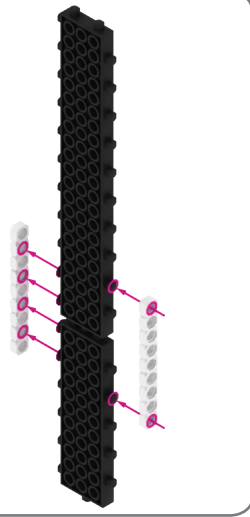
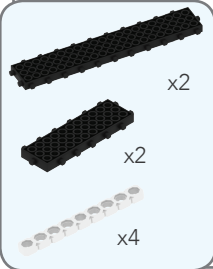

08

X2

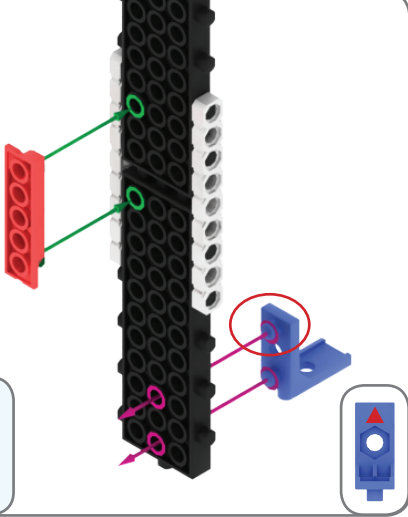
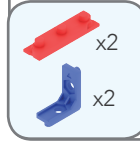

09

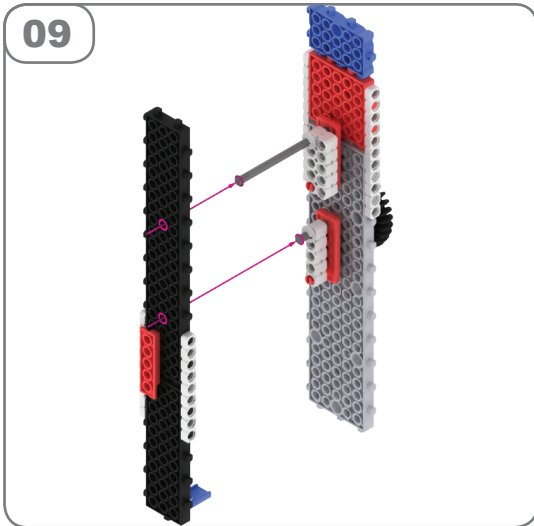

10

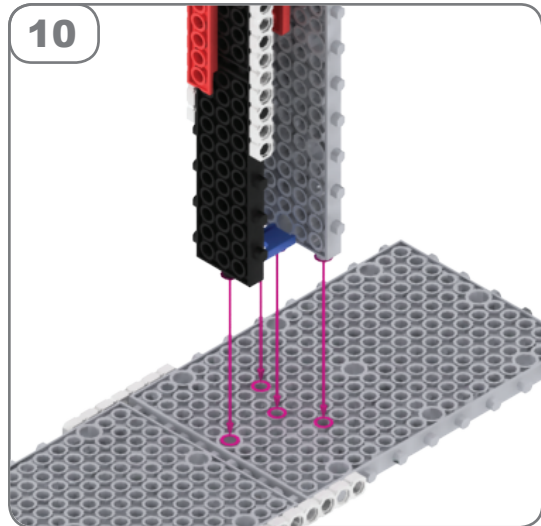

11

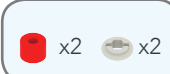
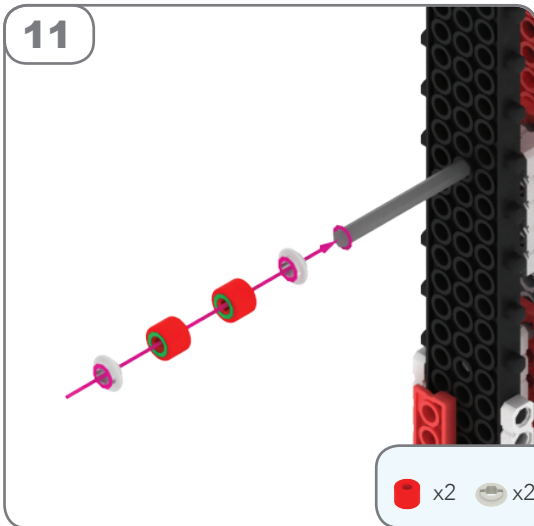

12

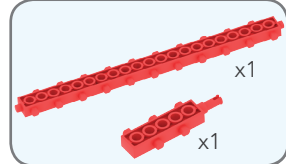
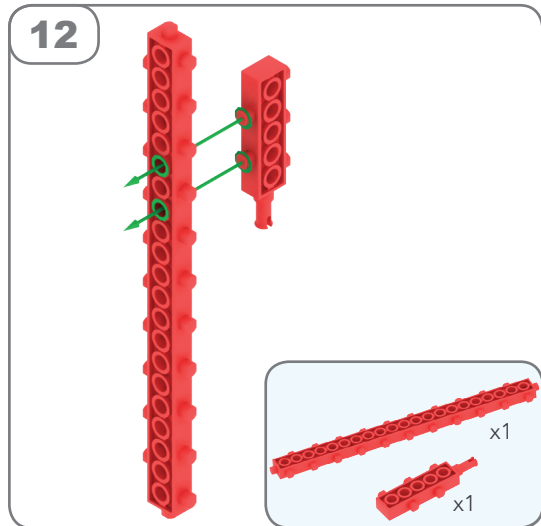

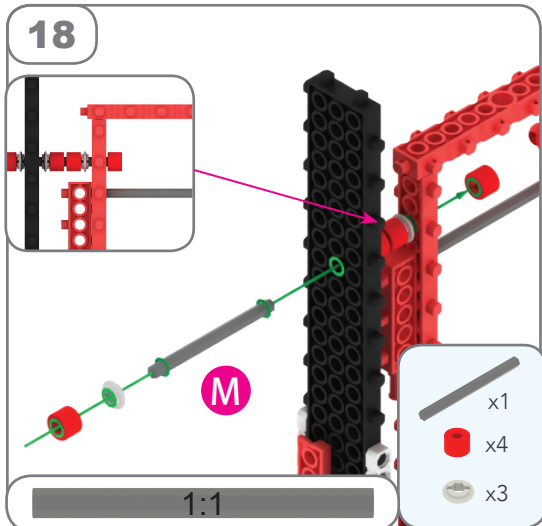
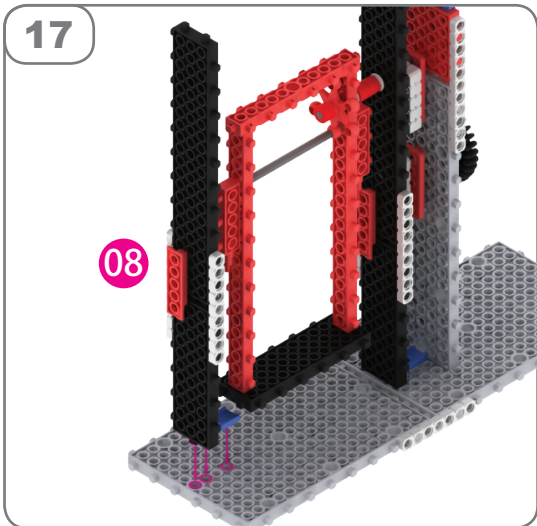
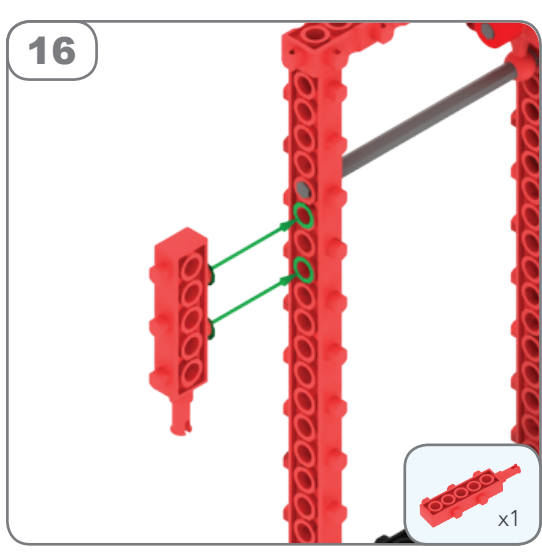
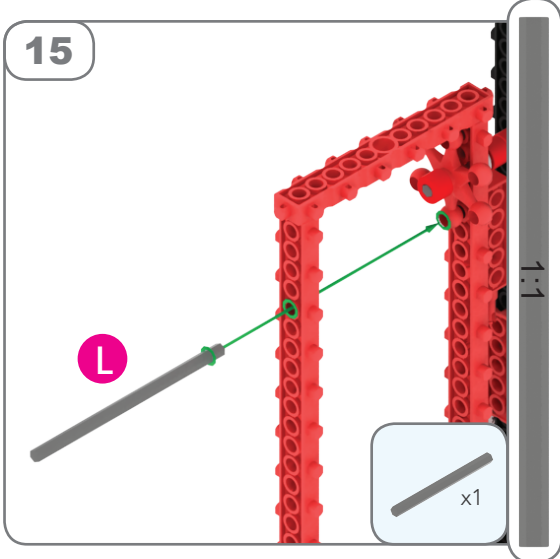
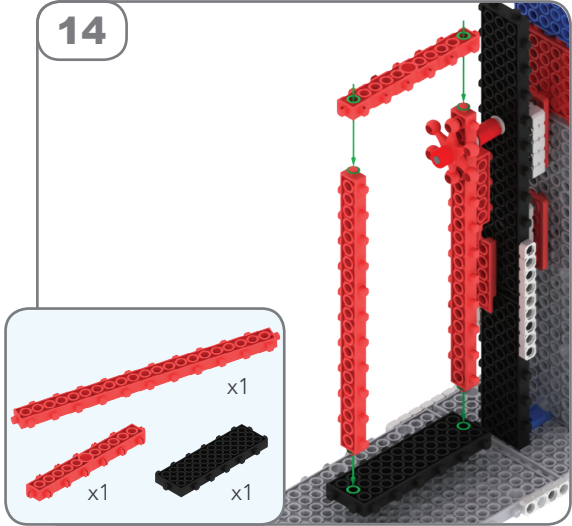
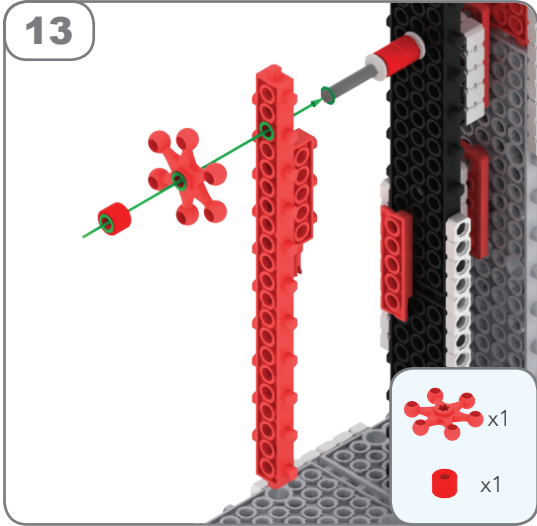

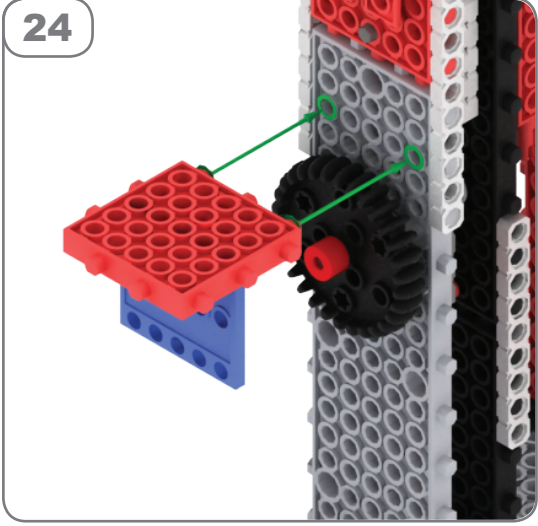
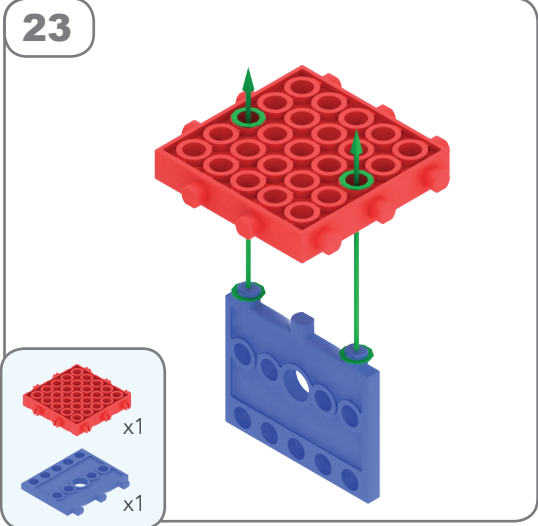
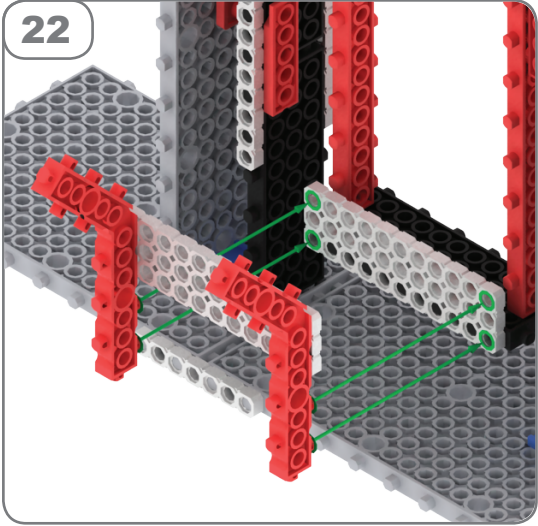
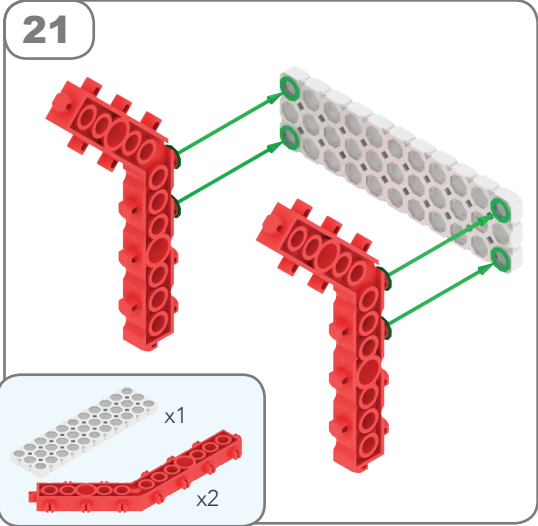
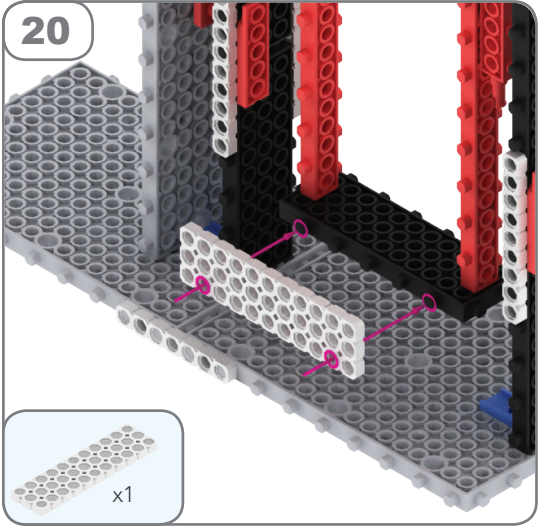
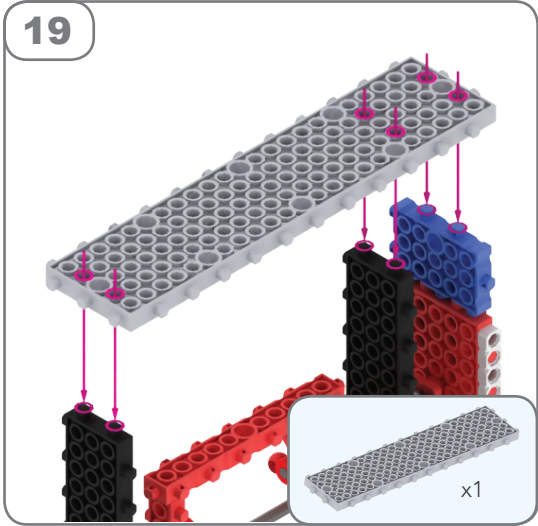

25 1:1

M

- x1
- x1
- x2

26

- x1
- x1
- x2

27

- x1
- x1
- x1

28

29

- x1
- x1
- x2

30

31

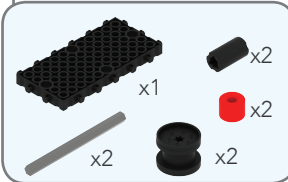
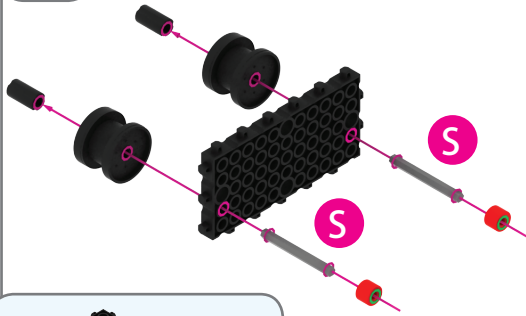

1:1

32

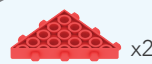
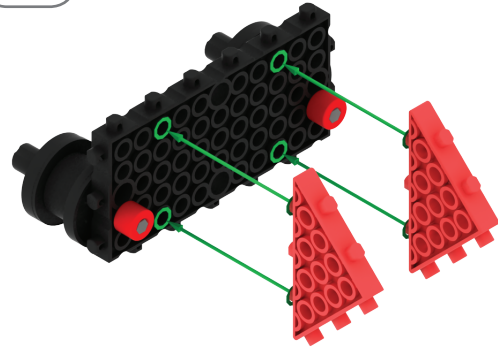

33

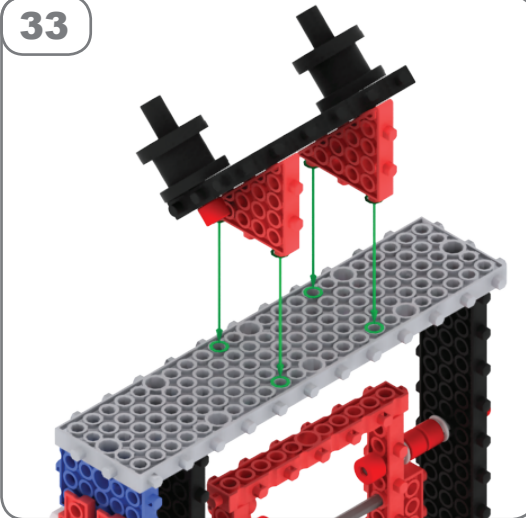

34

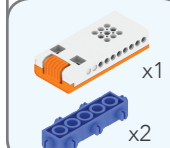
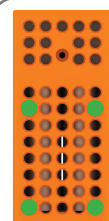
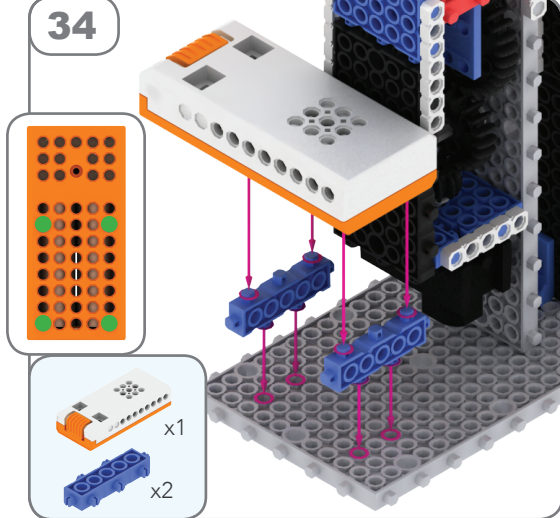

Nota: Este triángulo rojo ▲ señala la posición

35

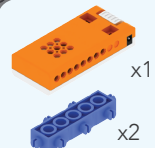
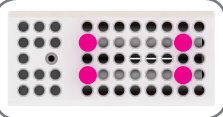
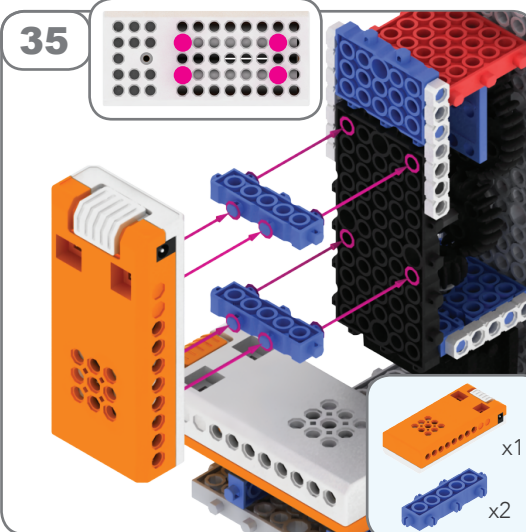

36

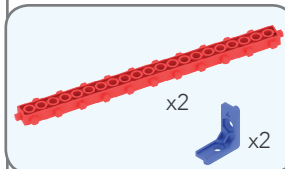
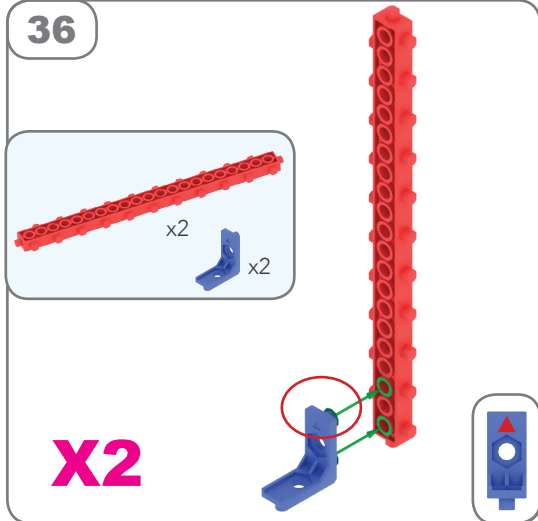

X2

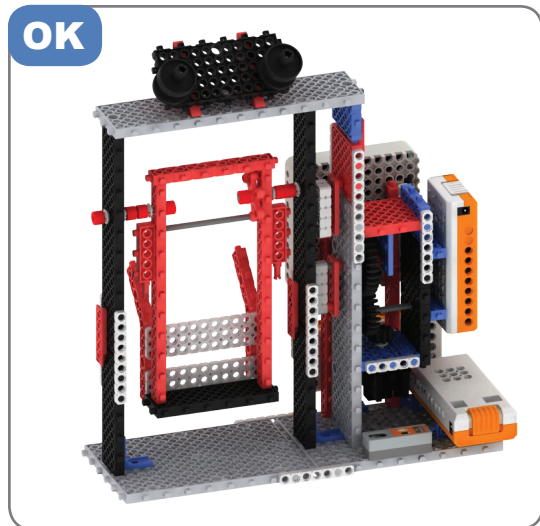
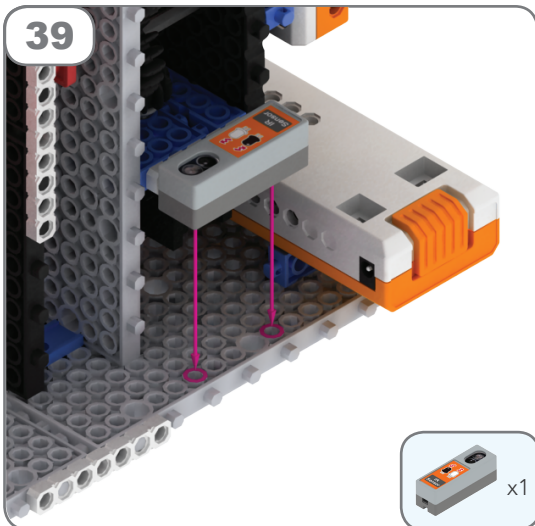
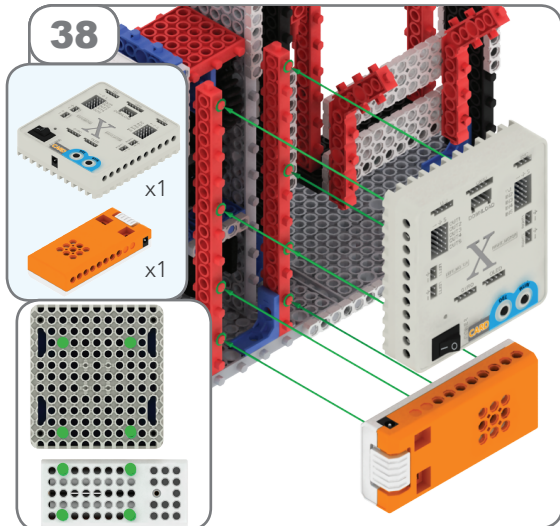
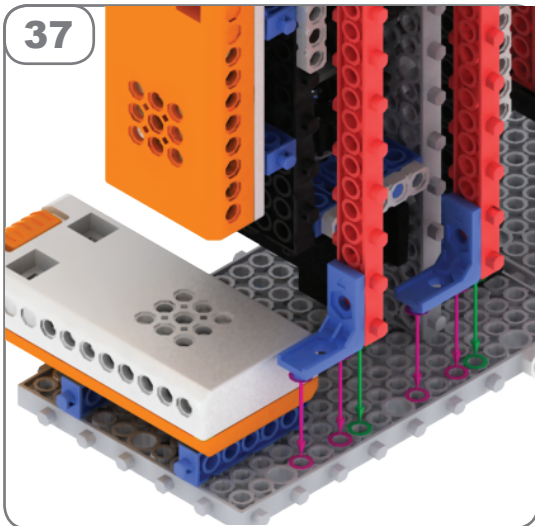

¿Cómo hacer la conexión?

Haz que el ▲ se corresponda con el ▲ del lector de tarjetas

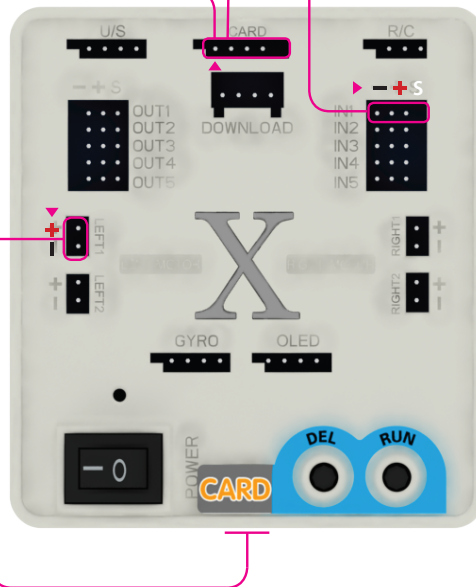
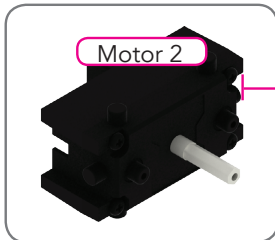
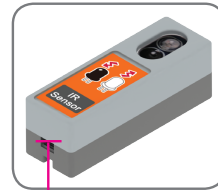

Para una descripción más detallada, consulta la sección «Consejos para un buen montaje» del fascículo.



Programación:

1. Cycle start (all time)
2. IF IN1
3. Forward
4. IF NOT
5. Stop
6. Cycle end

Consulta la sección «Aprende a programar» del fascículo: en ella encontrarás una explicación más detallada y más ejemplos de programación.



IF-IN1



IF-NOT



Cycle start (all time)



Cycle end

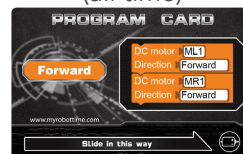

Forward



Stop