

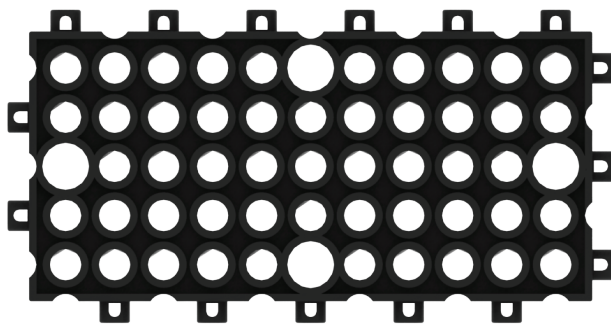

23 Gusano



Piezas



Bloque 5x11 (1)

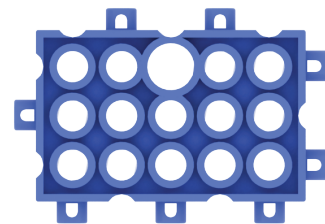

Bloque 3x5 (4)



Bloque N 2x11 (2)



Rueda M (2)



Bloque N 1x7 (4)



Manivela (2)



Bloque de unión (4)

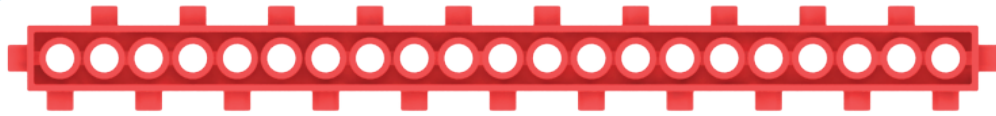

Bloque 1x21 (2)

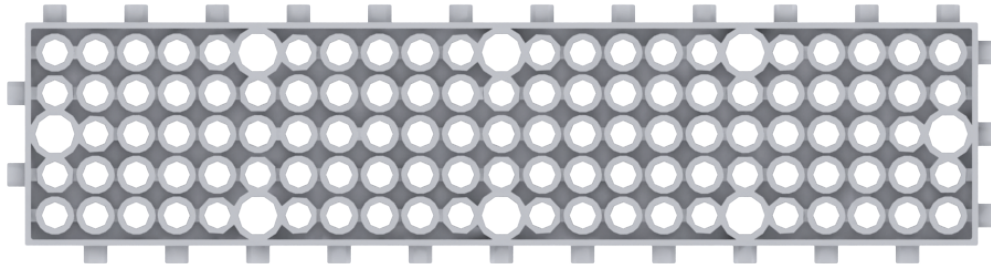

Bloque 5x23 (2)

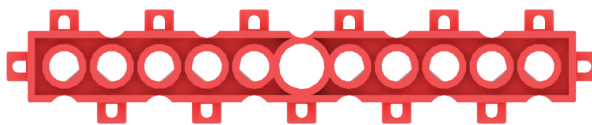

Bloque 1x11 (1)

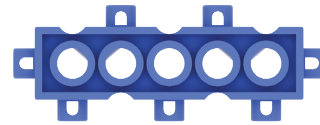

Bloque 1x5 (3)



Engranaje L (1)

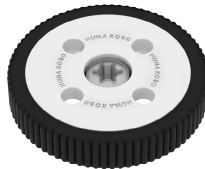

Rueda M (2)

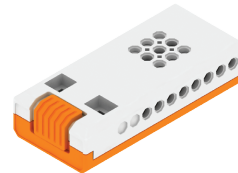

Portapilas o portabaterías 1 (1)

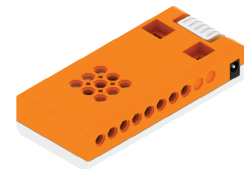

Portapilas o portabaterías 2 (2)



Conector de eje (2)



Engranaje S (1)



Engranaje M (1)

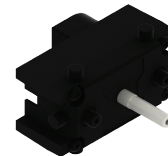

Motor 2 (1)



S-shaft

Eje S (1)



Cable de Conexión (3)



M-shaft

Eje M (2)



L-shaft

Eje L (3)



Goma de eje roja (13)



Arandela (2)



Unión de ejes (2)



Placa base (1)

01

1:1

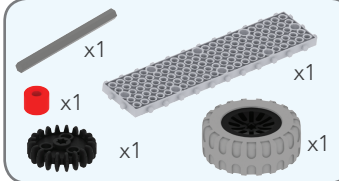
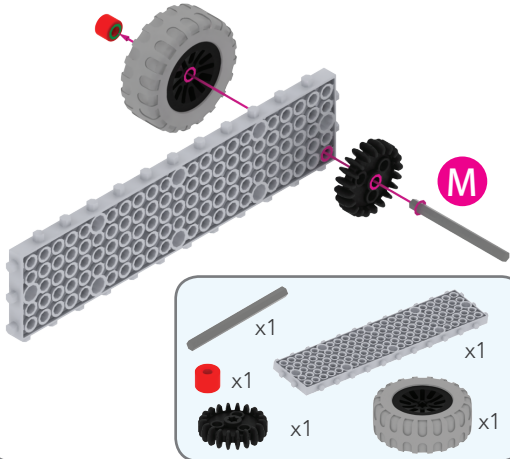

02

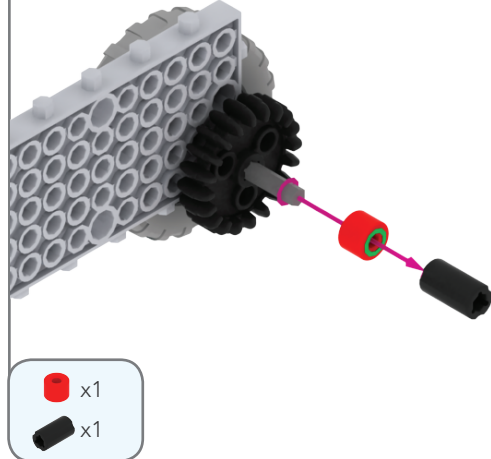

03

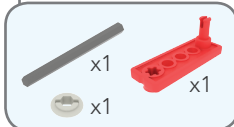
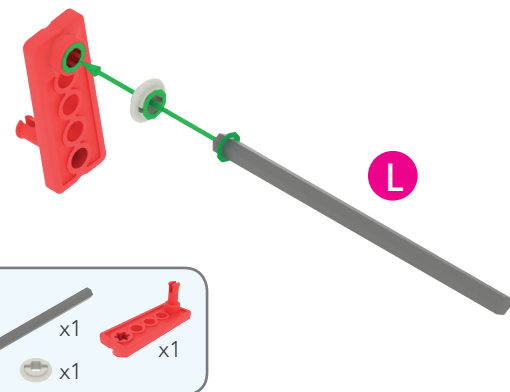

1:1

04

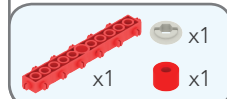
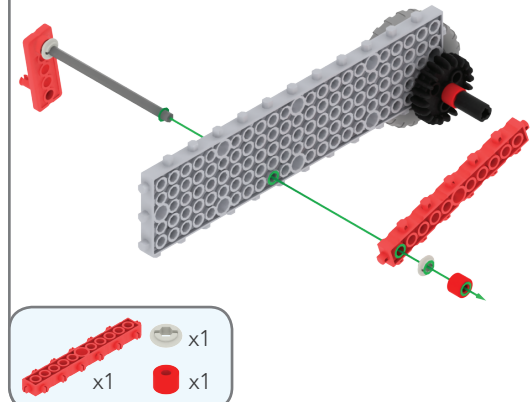

05

1:1

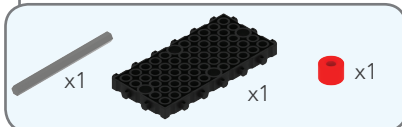
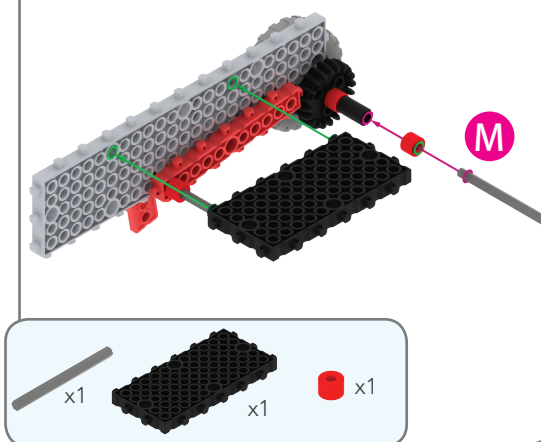

06

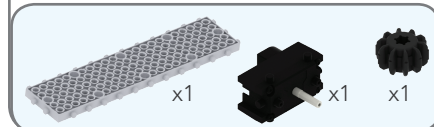
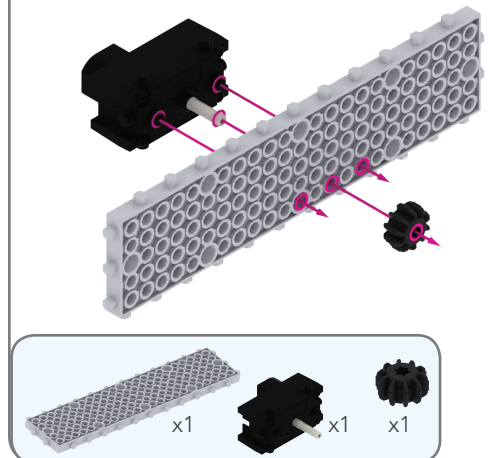

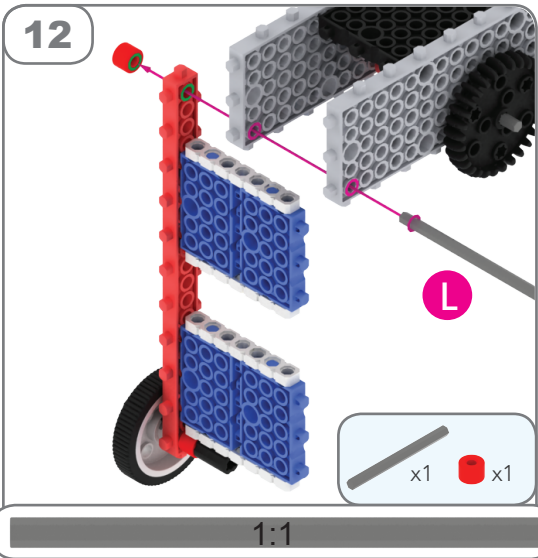
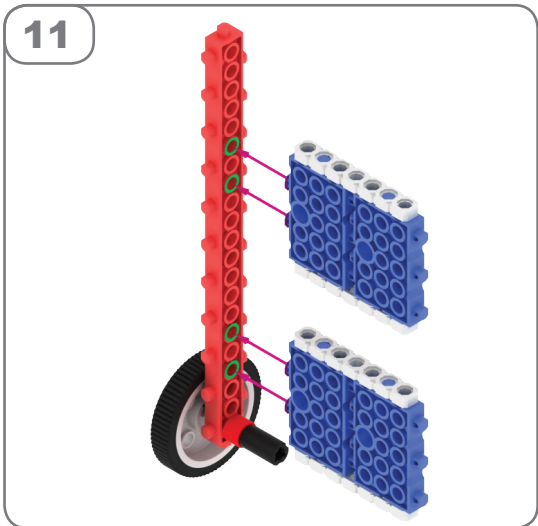
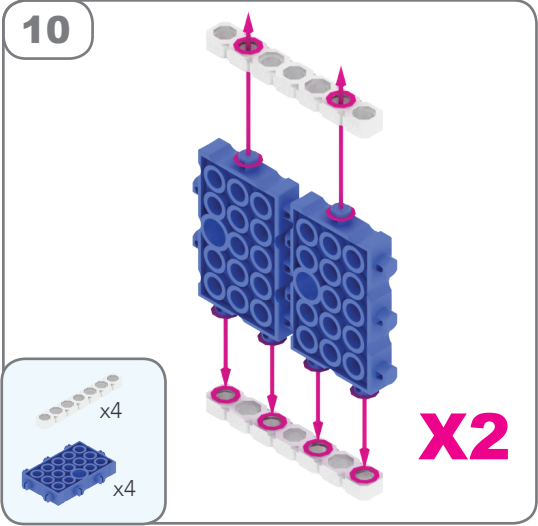
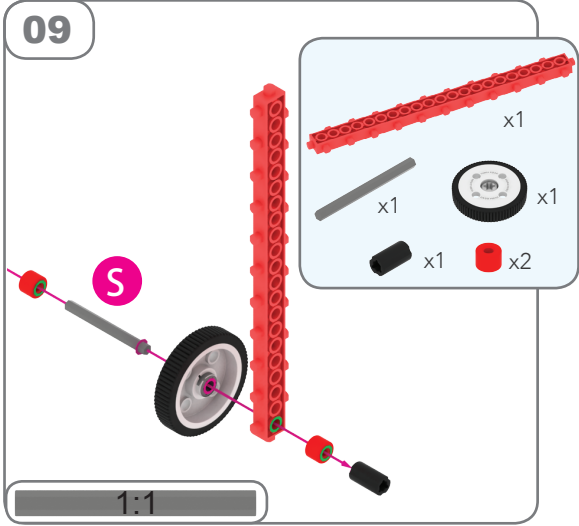
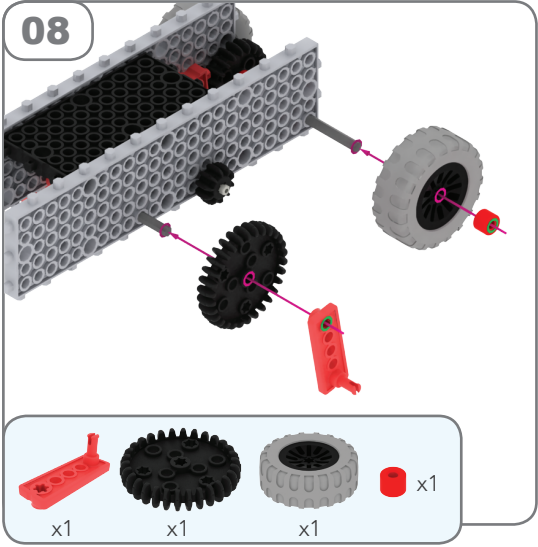
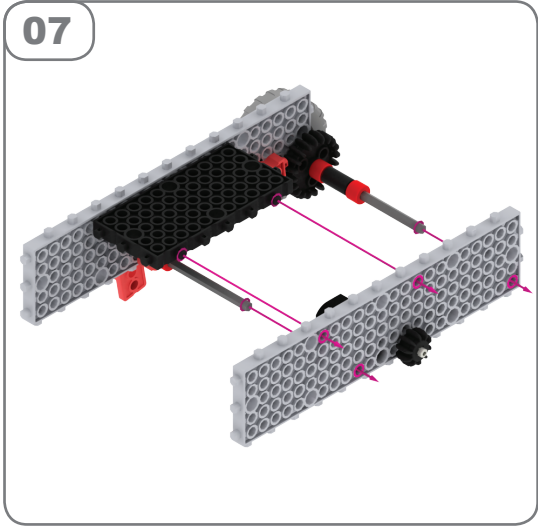

13

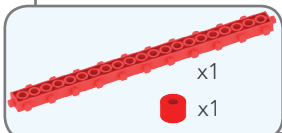
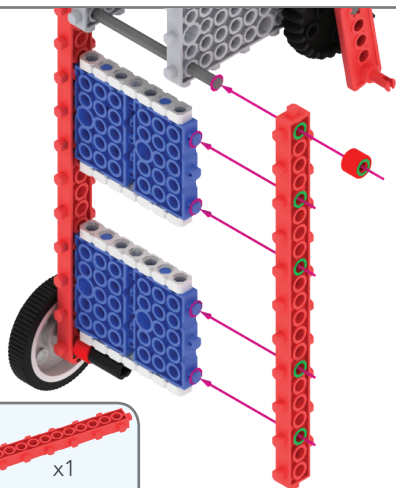

1:1

14

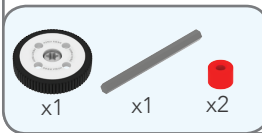
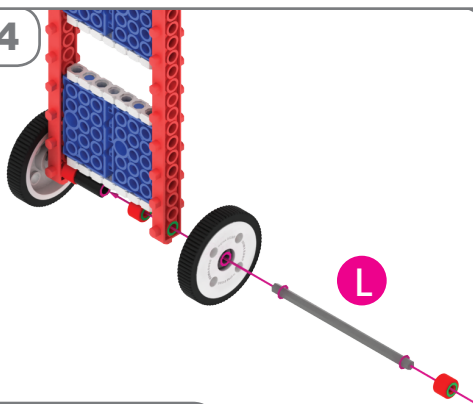

15

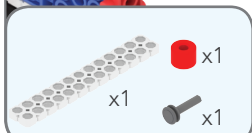
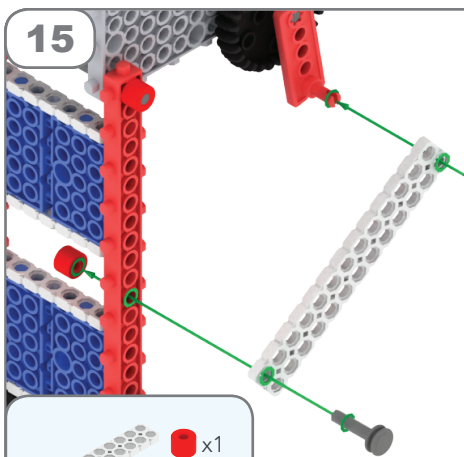

16

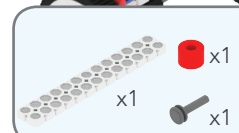
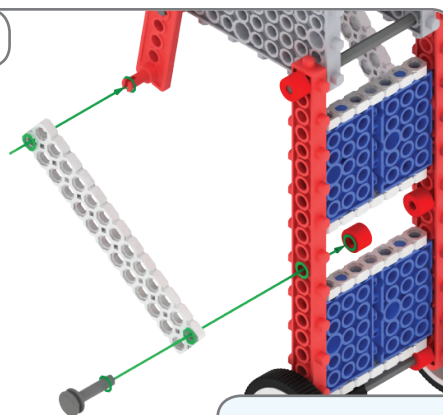

17

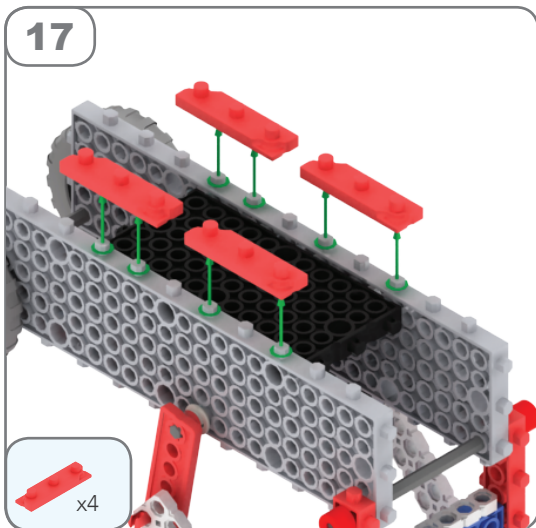

18

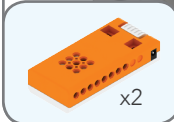
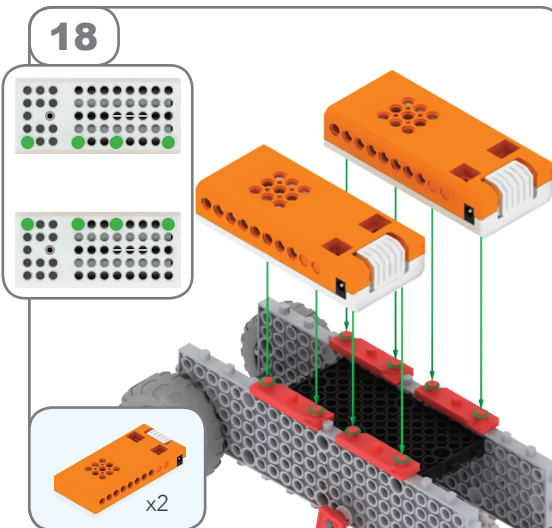

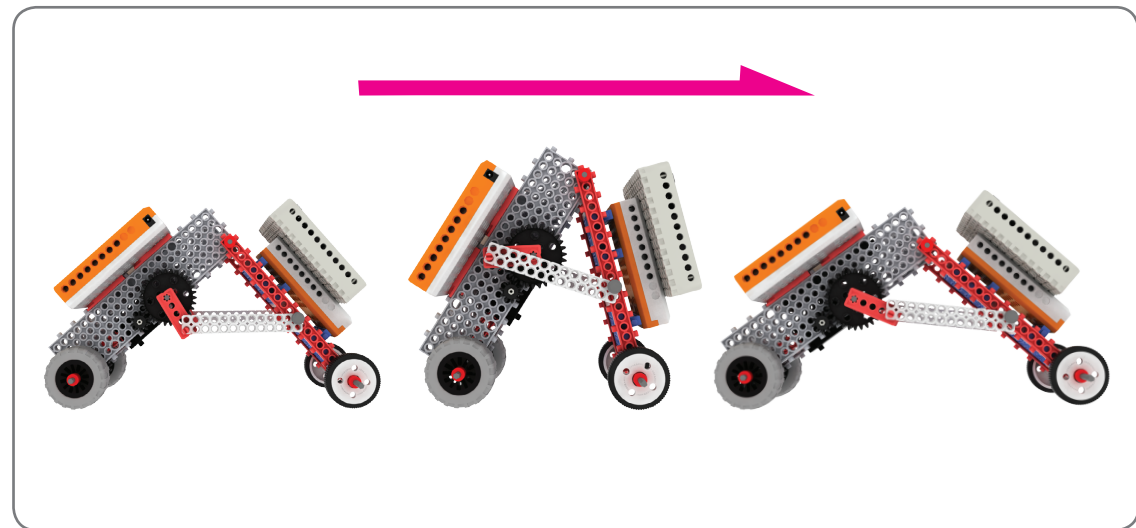
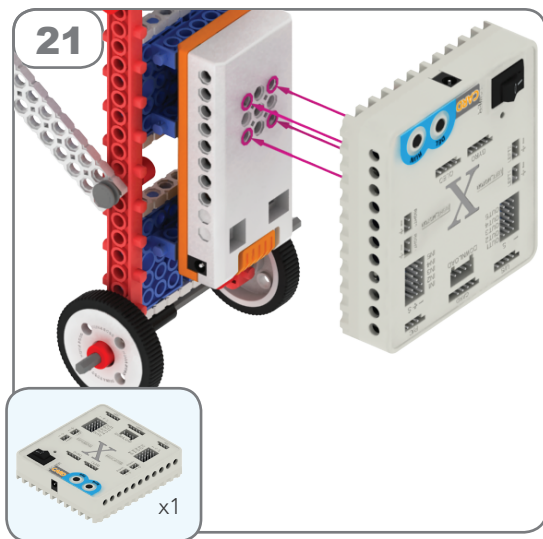
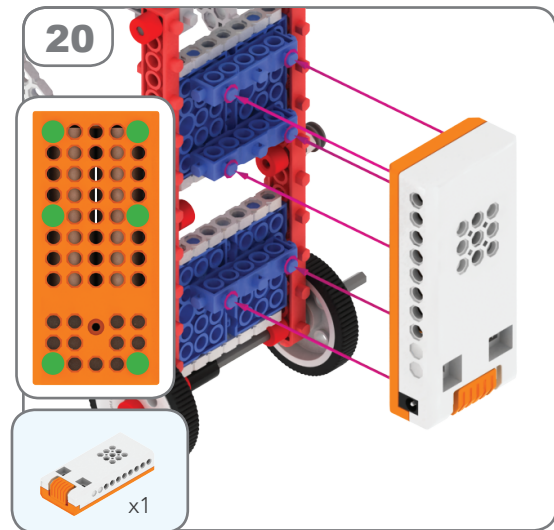
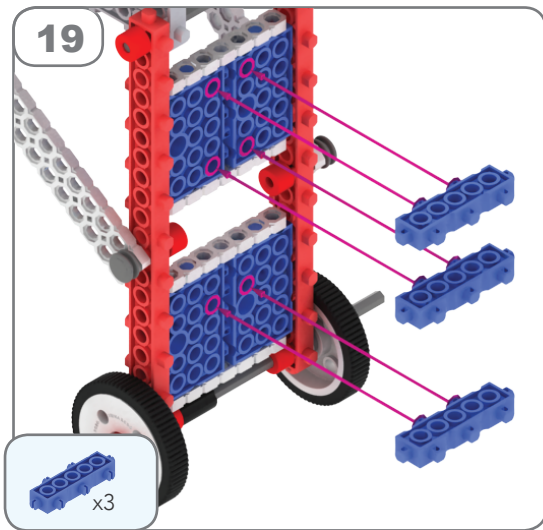

¿Cómo hacer la conexión?

Haz que el ▲ se corresponda con el ▲ del lector de tarjetas

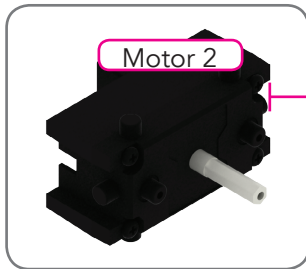

Para una descripción más detallada, consulta la sección «Consejos para un buen montaje» del fascículo.

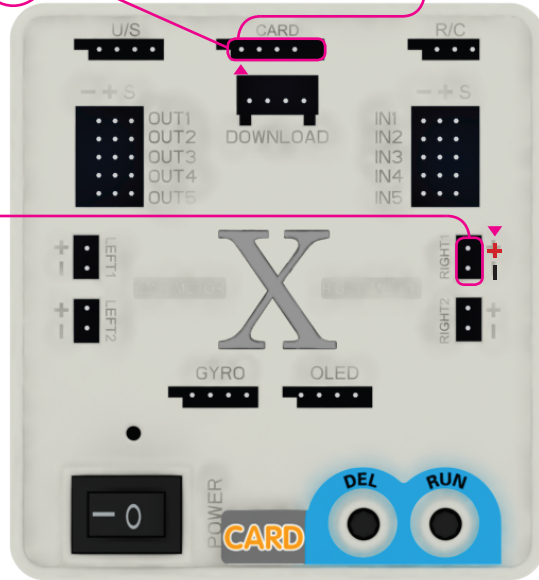

Consulta la sección «Aprende a programar» del fascículo: en ella encontrarás una explicación más detallada y más ejemplos de programación.



Forward



Stop



Delay 1 sec

Programación:

1. Forward
2. Delay 1 sec
3. Delay 1 sec
4. Delay 1 sec
5. Delay 1 sec
6. Delay 1 sec
7. Stop